

## Vehicle History Report™

US \$44.99

---

**2011 TOYOTA SIENNA LIMITED 7-PASSENGER**  
 VIN: 5TDYK3DC8BS036263  
 VAN  
 3.5L V6 F DOHC 24V  
 GASOLINE  
 FRONT WHEEL DRIVE

**Damage reported: minor damage**



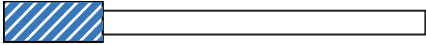

MINOR      MODERATE      SEVERE

---

 **21** Service history records

---

 **2** Previous owners

---

 Types of owners: Personal lease, Personal

---

 **132,733** Last reported odometer reading

This CARFAX Vehicle History Report is based only on information supplied to CARFAX and available as of 7/9/23 at 10:41:03 AM (CDT). Other information about this vehicle, including problems, may not have been reported to CARFAX. Use this report as one important tool, along with a vehicle inspection and test drive, to make a better decision about your next used car.

 <b>Ownership History</b> <small>The number of owners is estimated</small>	Owner 1	Owner 2
Year purchased	2010	2013
Type of owner	Personal lease	Personal
Estimated length of ownership	2 yrs. 6 mo.	8 yrs. 4 mo.
Owned in the following states/provinces	Washington	California
Estimated miles driven per year	12,341/yr	11,931/yr
Last reported odometer reading	32,293	132,733

 <b>Title History</b> <small>CARFAX guarantees the information in this section</small>	Owner 1	Owner 2
<b>Damage Brands</b> Salvage   Junk   Rebuilt   Fire   Flood   Hail   Lemon	<input checked="" type="checkbox"/> <b>Guaranteed</b> No Problem	<input checked="" type="checkbox"/> <b>Guaranteed</b> No Problem
<b>Odometer Brands</b> Not Actual Mileage   Exceeds Mechanical Limits	<input checked="" type="checkbox"/> <b>Guaranteed</b> No Problem	<input checked="" type="checkbox"/> <b>Guaranteed</b> No Problem



**GUARANTEED** - None of these major title problems were reported by a state Department of Motor Vehicles (DMV). If you find that any of these title problems were reported by a DMV and not included in this report, CARFAX will buy this vehicle back.  
View Terms | View Certificate

<b>CARFAX</b> Additional History Not all accidents / issues are reported to CARFAX	Owner 1	Owner 2
<b>Total Loss</b> No total loss reported to CARFAX.	✓ No Issues Reported	✓ No Issues Reported
<b>Structural Damage</b> CARFAX recommends that you have this vehicle inspected by a collision repair specialist.	✓ No Issues Reported	✓ No Issues Reported
<b>Airbag Deployment</b> No airbag deployment reported to CARFAX.	✓ No Issues Reported	✓ No Issues Reported
<b>Odometer Check</b> No indication of an odometer rollback.	✓ No Issues Indicated	✓ No Issues Indicated
<b>Accident / Damage</b> Damage reported: 04/01/2016 and 09/27/2016.	✓ No Issues Reported	Minor Damage
<b>Manufacturer Recall</b> No open recalls reported to CARFAX. Check with an authorized Toyota dealer for any open recalls. View Toyota disclosure	✓ No Recalls Reported	✓ No Recalls Reported
<b>Basic Warranty</b> Original warranty estimated to have expired.	Warranty Expired	Warranty Expired

## **CARFAX** Detailed History



### Owner 1

Purchased: 2010















**Low mileage!** This owner drove less than the industry average of 15,000 miles per year.

Personal Lease Vehicle  
12,341 mi/yr

Date	Mileage	Source	Comments
05/03/2010		NICB	<b>Vehicle manufactured and shipped to original dealer</b>
08/10/2010		Dick Hannah Toyota Vancouver, WA 360-501-3033 <a href="https://dickhannahtoyota.com">https://dickhannahtoyota.com</a> ★ 4.4 / 5.0 99 Verified Reviews	<b>Vehicle serviced</b> - Vehicle washed/detailed

 **94** Customer Favorites



08/28/2010	218	Dick Hannah Toyota Vancouver, WA 360-425-2730 <a href="https://dickhannahtoyota.com">https://dickhannahtoyota.com</a>  <b>4.4 / 5.0</b> 99 Verified Reviews  <b>94</b> Customer Favorites	<b>Vehicle sold</b>
09/21/2010		Washington Motor Vehicle Dept. Vancouver, WA	<b>Title issued or updated</b> - First owner reported - Titled or registered as personal lease vehicle
12/14/2010	5,138	Dick Hannah Toyota Vancouver, WA 360-501-3033 <a href="https://dickhannahtoyota.com">https://dickhannahtoyota.com</a>  <b>4.4 / 5.0</b> 99 Verified Reviews  <b>94</b> Customer Favorites	 <b>Vehicle serviced</b> - Recommended maintenance performed - Maintenance inspection completed - Four tires balanced - Four tires mounted - Tire condition and pressure checked
04/01/2011	9,011	Dick Hannah Toyota Vancouver, WA 360-501-3033 <a href="https://dickhannahtoyota.com">https://dickhannahtoyota.com</a>  <b>4.4 / 5.0</b> 99 Verified Reviews  <b>94</b> Customer Favorites	 <b>Vehicle serviced</b> - Recommended maintenance performed - Maintenance inspection completed - Four tires balanced - Four tires mounted - Tire condition and pressure checked - Vehicle washed/detailed
08/19/2011		Washington Motor Vehicle Dept. Vancouver, WA Title #1026426414	<b>Registration issued or renewed</b>
09/24/2011	15,994	Dick Hannah Toyota Vancouver, WA 360-501-3033 <a href="https://dickhannahtoyota.com">https://dickhannahtoyota.com</a>  <b>4.4 / 5.0</b> 99 Verified Reviews  <b>94</b> Customer Favorites	 <b>Vehicle serviced</b> - Maintenance inspection completed - 15,000 mile service performed - Tire condition and pressure checked - Vehicle washed/detailed
01/16/2012	20,132	Dick Hannah Toyota Vancouver, WA 360-501-3033	 <b>Vehicle serviced</b> - Maintenance inspection completed - 20,000 mile service performed - Tire condition and pressure checked

<https://dickhannahtoyota.com>

★ **4.4 / 5.0**



99 Verified Reviews

♥ **94** Customer Favorites

09/26/2012	27,868	California Inspection Station Sacramento, CA	<b>Passed emissions inspection</b>
09/28/2012		Washington Motor Vehicle Dept. Vancouver, WA Title #1026426414	<b>Registration issued or renewed</b>
04/07/2013		Infiniti of Elk Grove Elk Grove, CA 916-405-7000 infinitiofelkgrove.com ★ <b>4.7 / 5.0</b> 118 Verified Reviews ♥ <b>351</b> Customer Favorites	<b>Vehicle offered for sale</b>
04/15/2013	31,682	Maita Toyota Sacramento, CA 800-640-6248 maitacars.com ★ <b>4.2 / 5.0</b> 1,112 Verified Reviews ♥ <b>13,704</b> Customer Favorites	 <b>Vehicle serviced</b> - Maintenance inspection completed
04/16/2013	31,770	Nissan of Elk Grove Elk Grove, CA 916-405-5000 nissanofelkgrove.com ★ <b>4.6 / 5.0</b> 348 Verified Reviews ♥ <b>1,330</b> Customer Favorites	 <b>Vehicle serviced</b> - Emission system checked
04/16/2013		Infiniti of Elk Grove Elk Grove, CA 916-405-7000 infinitiofelkgrove.com ★ <b>4.7 / 5.0</b> 118 Verified Reviews ♥ <b>351</b> Customer Favorites	 <b>Vehicle serviced</b> - Vehicle washed/detailed



Looks like this dealer serviced the car in order to prepare it for sale. That's a good thing!

04/16/2013		California Inspection Station Elk Grove, CA	<b>Passed emissions inspection</b>
04/25/2013	31,771	Infiniti of Elk Grove Elk Grove, CA 916-405-7000 infinitiofelkgrove.com ★ <b>4.7 / 5.0</b> 118 Verified Reviews ❤️ <b>351</b> Customer Favorites	<b>Odometer reading reported</b>
05/30/2013	31,774	Infiniti of Elk Grove Elk Grove, CA 916-405-7000 infinitiofelkgrove.com ★ <b>4.7 / 5.0</b> 118 Verified Reviews ❤️ <b>351</b> Customer Favorites	<b>Odometer reading reported</b>
05/31/2013		Nissan of Elk Grove Elk Grove, CA 916-405-5000 nissanofelkgrove.com ★ <b>4.6 / 5.0</b> 348 Verified Reviews ❤️ <b>1,330</b> Customer Favorites	 <b>Vehicle serviced</b>
06/20/2013	31,775	Elk Grove Honda Elk Grove, CA 916-226-7000 elkgrovehonda.com ★ <b>4.7 / 5.0</b> 656 Verified Reviews ❤️ <b>8,108</b> Customer Favorites	 <b>Vehicle serviced</b> - Vehicle washed/detailed - Safety inspection performed
			Looks like this dealer serviced the car in order to prepare it for sale. That's a good thing!
06/20/2013	31,792	Elk Grove Honda Elk Grove, CA 916-226-7000 elkgrovehonda.com ★ <b>4.7 / 5.0</b> 656 Verified Reviews ❤️ <b>8,108</b> Customer Favorites	<b>Vehicle offered for sale</b>
07/01/2013		Auto Auction	<b>Listed as a dealer vehicle</b>

- Vehicle sold



Millions of used vehicles are bought and sold at auction every year.

07/02/2013		Dealer Inventory		<b>Vehicle offered for sale</b>
09/09/2013		Auto Auction		<b>Listed as a dealer vehicle</b> - Vehicle sold
09/11/2013	32,253	Elk Grove Honda Elk Grove, CA 916-226-7000 elkgrovehonda.com ★ <b>4.7 / 5.0</b> 656 Verified Reviews ❤️ <b>8,108</b> Customer Favorites		<b>Vehicle serviced</b>
09/11/2013	32,280	Dealer Inventory		<b>Vehicle offered for sale</b>
09/11/2013	32,293	Dublin Toyota Dublin, CA 925-829-7700 dublintoysota.com ★ <b>4.2 / 5.0</b> 243 Verified Reviews ❤️ <b>10,810</b> Customer Favorites		<b>Vehicle serviced</b> - Front brake rotor(s) resurfaced - Four tires balanced - Four tires mounted - Oil and filter changed - Brakes checked - Tire condition and pressure checked - Wheels checked - Vehicle washed/detailed - Emissions inspection performed
10/02/2013		California Inspection Station Dublin, CA		<b>Passed emissions inspection</b>
10/04/2013		Toyota Certified Dealer Dublin, CA  		<b>Offered for sale as a Toyota Certified Used Vehicle</b> - Silver metallic exterior - Ash interior

**Owner 2**  
Purchased: 2013

**Low mileage!** This owner drove less than the industry average of 15,000 miles per year.

Personal Vehicle  
11,931 mi/yr

Date	Mileage	Source	Comments
11/15/2013	32,306	California Motor Vehicle Dept.	<b>Odometer reading reported</b>

Belmont, CA

12/04/2013

California  
Motor Vehicle Dept.  
Belmont, CA

**Title issued or updated**

- New owner reported
- Loan or lien reported

11/25/2014 45,360

Pep Boys  
San Carlos, CA  
650-632-1522  
pepboys.com



**Vehicle serviced**

- Tire(s) balanced
- Tire(s) mounted
- Alignment performed
- Tire pressure monitoring system serviced

★ **4.1 / 5.0**  
82 Verified Reviews  
♥ **176** Customer Favorites

02/05/2015

California  
Motor Vehicle Dept.  
Belmont, CA

**Title issued or updated**

- Loan or lien reported

10/09/2015

Pep Boys  
San Carlos, CA  
650-632-1522  
pepboys.com



**Vehicle serviced**

- Maintenance inspection completed
- Brakes checked

★ **4.1 / 5.0**  
82 Verified Reviews  
♥ **176** Customer Favorites

04/01/2016

Damage Report



**Damage reported: minor damage**

- Damage to front



**CARFAX HAS THE MOST  
ACCIDENT & DAMAGE  
INFORMATION**

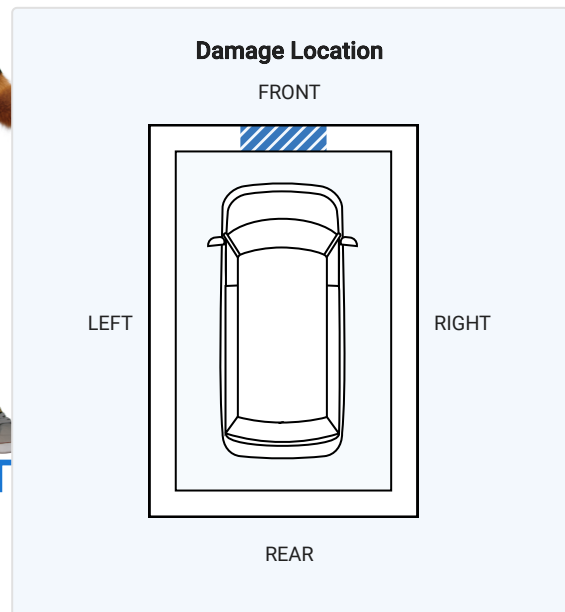
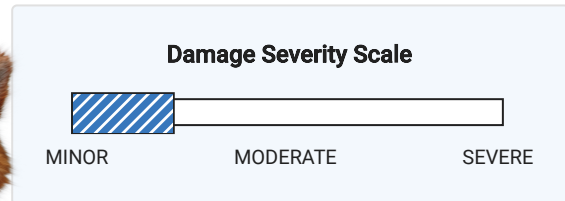



Minor damage is usually cosmetic, including dents or scratches to the vehicle body.

09/27/2016

Damage Report



**Damage reported: minor damage**  
- Damage to front



**CARFAX HAS THE MOST ACCIDENT & DAMAGE INFORMATION**

**Damage Severity Scale**

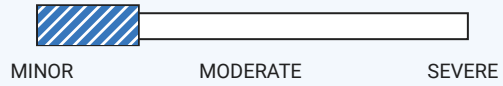

**Damage Location**

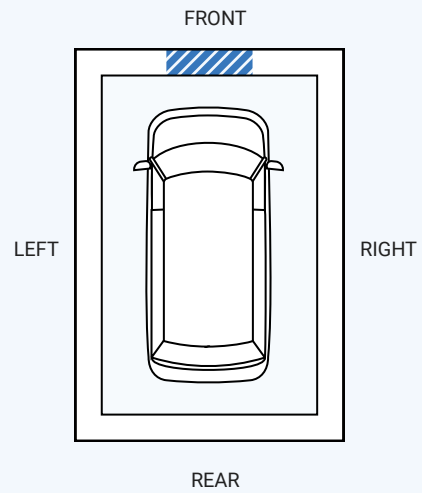

Minor damage is usually cosmetic, including dents or scratches to the vehicle body.

11/23/2016 67,676

College Plaza Shell  
San Mateo, CA  
650-573-7959



**Vehicle serviced**

- Battery replaced
- Tire condition and pressure checked

01/02/2017 68,651

OilStop, Inc.  
San Mateo, CA  
650-572-8000  
oilstopinc.com

★ **4.6 / 5.0**

112 Verified Reviews

♥ **202** Customer Favorites



**Vehicle serviced**

- Air filter replaced
- Cabin air filter replaced/cleaned
- Oil and filter changed
- Drain plug gasket replaced
- Engine oil system flushed

10/14/2017 79,985











Autolube Express Oil  
Change  
Lodi, CA  
209-625-8737



**Vehicle serviced**

- Engine oil/fluid leak checked
- Air filter replaced
- PCV valve replaced



		<p>autolube.express/   <b>4.8 / 5.0</b>            143 Verified Reviews   <b>1,277</b> Customer Favorites</p>	<ul style="list-style-type: none"> <li>- Antifreeze/coolant flushed/changed</li> <li>- Oil and filter changed</li> <li>- Engine oil system flushed</li> </ul>
11/28/2017	81,725	California Inspection Station	<b>Passed emissions inspection</b>
12/11/2019	110,959	California Inspection Station	<b>Failed emissions inspection</b>
12/24/2019		California Motor Vehicle Dept. Redwood City, CA	<b>Registration updated when owner moved the vehicle to a new location</b>
01/17/2020	111,975	<p>Redwood General Tire - Tire Pros            Redwood City, CA            650-369-0351            redwoodgeneral.com/   <b>4.8 / 5.0</b>            90 Verified Reviews   <b>161</b> Customer Favorites</p>	 <b>Vehicle serviced</b> <ul style="list-style-type: none"> <li>- Brakes checked</li> <li>- Tire(s) replaced</li> </ul>
05/27/2020	115,355	<p>Toyota 101            Redwood City, CA            650-365-5000            toyota101.com   <b>4.4 / 5.0</b>            71 Verified Reviews   <b>5,363</b> Customer Favorites</p>	 <b>Vehicle serviced</b> <ul style="list-style-type: none"> <li>- Maintenance inspection completed</li> <li>- 5,000 mile service performed</li> <li>- Air filter replaced</li> <li>- Cabin air filter replaced/cleaned</li> <li>- Brake fluid flushed/changed</li> <li>- Rear brake pads replaced</li> <li>- Brake rotor(s) resurfaced</li> <li>- Oil and filter changed</li> <li>- Tires rotated</li> <li>- Oxygen sensor replaced</li> <li>- Engine/powertrain computer/module checked</li> <li>- Tire condition and pressure checked</li> </ul>
12/29/2020	119,894	California Inspection Station	<b>Passed emissions inspection</b>
06/18/2021	124,115	California Inspection Station	<b>Passed emissions inspection</b>
08/24/2021	126,014	<p>Toyota 101            Redwood City, CA            650-365-5000            toyota101.com   <b>4.4 / 5.0</b>            71 Verified Reviews   <b>5,363</b> Customer Favorites</p>	 <b>Vehicle serviced</b> <ul style="list-style-type: none"> <li>- 120,000 mile service performed</li> <li>- Steering/suspension checked</li> <li>- Tire condition and pressure checked</li> <li>- Brakes checked</li> </ul>

01/17/2022	131,858	Toyota 101 Redwood City, CA 650-365-5000 toyota101.com ★ <b>4.4 / 5.0</b> 71 Verified Reviews ❤️ <b>5,363</b> Customer Favorites	 <b>Vehicle serviced</b> - Carpet/floor mats secured - Tire condition and pressure checked
03/28/2022	132,169	Auto Auction	<b>Listed as a dealer vehicle</b> - Vehicle sold
04/25/2022	132,172	Auto Auction	<b>Vehicle sold</b>
03/23/2023	132,733	California Inspection Station	<b>Passed emissions inspection</b>

Have Questions? Consumers, please visit our Help Center at [www.carfax.com](http://www.carfax.com). Dealers or Subscribers, please visit our Help Center at [www.carfaxonline.com](http://www.carfaxonline.com).



## Glossary

### Damage Indicator

Damage can be a result of many different types of events. Examples include contact with objects (other cars, trees, traffic signs, road debris, etc), vandalism, or weather-related events. Not every damage event is reported to CARFAX. As details about the damage event become available, those additional details are added to the CARFAX Vehicle History Report. CARFAX recommends that you have this vehicle inspected by a qualified mechanic.

- This CARFAX Vehicle History Report is based only on information supplied to CARFAX and available as of 7/9/23 at 10:41:03 AM (CDT). Other information about this vehicle, including problems, may not have been reported to CARFAX. Use this report as one important tool, along with a vehicle inspection and test drive, to make a better decision about your next used car.

### Damage Severity

Damage events result in one of the following severity levels:

- Minor: Generally, minor damage is cosmetic (including dents or scratches), may only require reconditioning, and typically does not compromise a vehicle's operation and/or safety.
- Moderate: Moderate damage may affect multiple components of the vehicle and may impair the vehicle's operation and/or safety.
- Severe: Severe damage usually affects multiple components of the vehicle and is likely to compromise the vehicle's operation and/or safety.

CARFAX recommends getting a pre-purchase inspection at a certified collision repair facility.

### Failed Emissions Inspection

The emissions check performed during a vehicle inspection indicated the vehicle was emitting more than allowable emissions standards and/or had missing or modified parts. Repeated failed emissions records can indicate engine problems and CARFAX recommends you have the vehicle inspected.

### First Owner

When the first owner(s) obtains a title from a Department of Motor Vehicles as proof of ownership.

### New Owner Reported

When a vehicle is sold to a new owner, the Title must be transferred to the new owner(s) at a Department of Motor Vehicles.

### Ownership History

CARFAX defines an owner as an individual or business that possesses and uses a vehicle. Not all title transactions represent changes in ownership. To provide estimated number of owners, CARFAX proprietary technology analyzes all the events in a vehicle history. Estimated ownership is available for vehicles manufactured after 1991 and titled solely in the US including Puerto Rico. Dealers sometimes opt to take ownership of a vehicle and are required to in the following states: Maine, Massachusetts, New Jersey, Ohio, Oklahoma, Pennsylvania and South Dakota. Please consider this as you review a vehicle's estimated ownership history.

**Title Issued**

A state issues a title to provide a vehicle owner with proof of ownership. Each title has a unique number. Each title or registration record on a CARFAX report does not necessarily indicate a change in ownership. In Canada, a registration and bill of sale are used as proof of ownership.

**Toyota Recall / Service Campaign**

Portions of this report have been included under license from Toyota Motor North America, Inc. ("TOYOTA"), License Agreement TMS1013 . This data applies only to vehicle marketed or originally sold in Mexico and the United States of America, including Guam, Saipan, American Samoa, Puerto Rico, the U.S. Virgin Islands and the other United States territories and protectorates with currently open safety or emissions recalls, or service campaigns. While TOYOTA provides data to Carfax Inc. on a regular basis, this report may not include very recent activity. For the manufacturer's most current information on recall/campaign activity for any Toyota, Lexus or Scion brand vehicle, you must go to <http://toyota.com/recall> or <http://lexus.com/recall>.

Follow Us:



[facebook.com/CARFAX](https://facebook.com/CARFAX)



[@CARFAXinc](https://twitter.com/CARFAXinc)



About CARFAX

CARFAX DEPENDS ON ITS SOURCES FOR THE ACCURACY AND RELIABILITY OF ITS INFORMATION. THEREFORE, NO RESPONSIBILITY IS ASSUMED BY CARFAX OR ITS AGENTS FOR ERRORS OR OMISSIONS IN THIS REPORT. CARFAX FURTHER EXPRESSLY DISCLAIMS ALL WARRANTIES, EXPRESS OR IMPLIED, INCLUDING ANY IMPLIED WARRANTIES OF MERCHANTABILITY OR FITNESS FOR A PARTICULAR PURPOSE.

© 2023 CARFAX, Inc., part of S&P Global. All rights reserved.  
7/9/23 10:41:03 AM (CDT)

**I have reviewed and received a copy of the CARFAX Vehicle History Report for this 2011 TOYOTA SIENNA vehicle (VIN: 5TDYK3DC8BS036263), which is based on information supplied to CARFAX and available as of 7/9/23 at 11:41 AM (EDT).**

Customer Signature

Date

Dealer Signature

Date

